

# Watts Radiant

Radiant Floors & Snowmelting  
 Ph: 417/864.6108  
 Fax: 417/864.8161

## GENERAL NOTES:

These diagrams typify factory-assembled manifolds. Field assembled manifolds must use Watts Heatway barb and connections components. Failure to use Watts Heatway materials may violate warranty. Refer to Submittal and/or Master Specification for more detailed information.

## SPECIFIER INFORMATION:

## MANIFOLD TYPE:

CAST BRASS

## PIPING:

- Residential     Heating  
 Commercial     Snowmelting  
 Floor Warming  
 Other \_\_\_\_\_

Zone(s): \_\_\_\_\_

Base Trunk Size:  1"     1-1/4"

No. of Barbs: \_\_\_\_\_

Tubing/Barb Size:

- 3/8"     1/2"     5/8"  
 3/4"     1"

Accessories:

- Unions  
 Vent/Purge Assembly  
 Trunk Isolation Valve  
 Balancing Valves - Supply  
 Balancing Valves - Return  
 No Balancing

Connections:

- Crimp Fittings  
 SlideLock Fittings  
 Compression Fittings

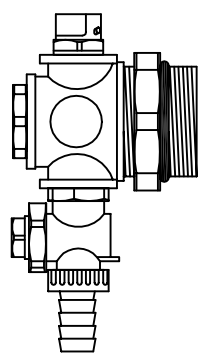
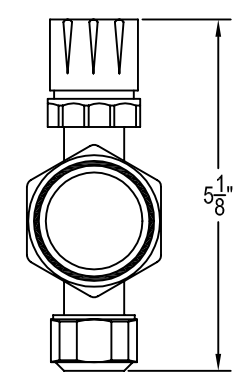
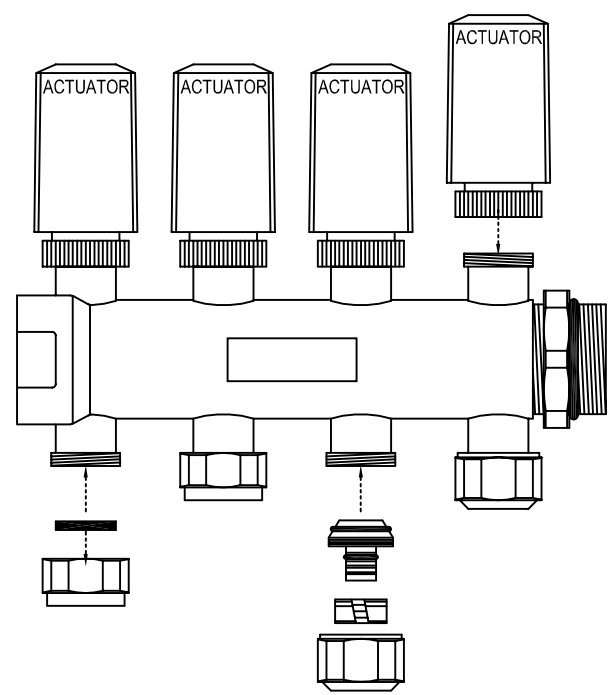
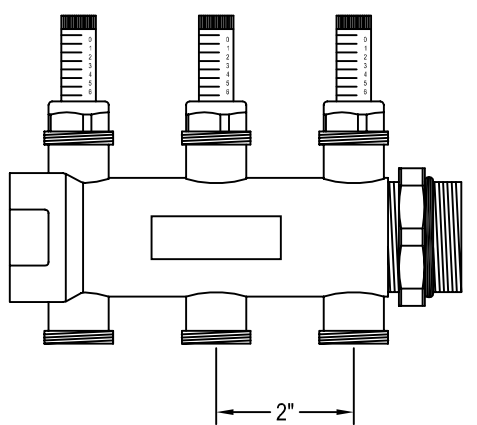
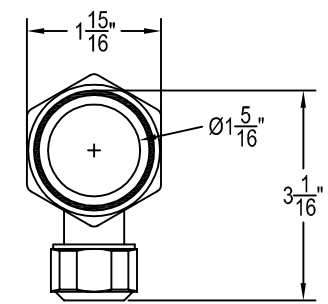
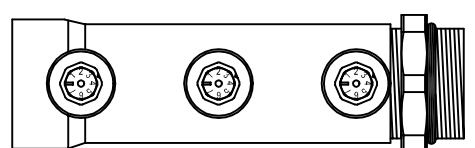
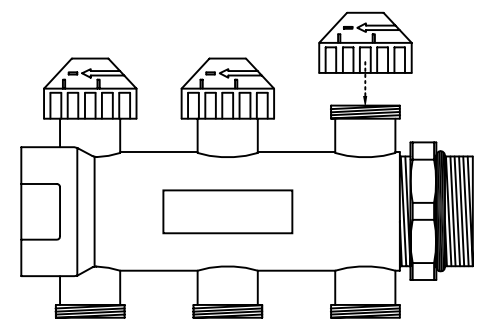

Vent/Purge End Assembly

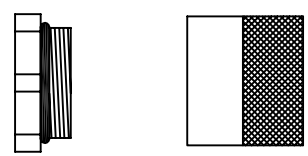

End Cap and Transitional Fitting

# Watts Radiant

Radiant Floors & Snowmelting

Ph: 417/864.6108

Fax: 417/864.8161

## GENERAL NOTES:

These diagrams typify factory-assembled manifolds. Field assembled manifolds must use Watts Heatway barb and connections components. Failure to use Watts Heatway materials may violate warranty. Refer to Submittal and/or Master Specification for more detailed information.

## SPECIFIER INFORMATION:

## MANIFOLD TYPE:

STAINLESS STEEL

## PIPING:

- Residential     Heating  
 Commercial     Snowmelting  
 Floor Warming  
 Other \_\_\_\_\_

Zone(s): \_\_\_\_\_  
 Base Trunk Size:  1"     1-1/4"  
 No. of Barbs: \_\_\_\_\_

Tubing/Barb Size:  
 3/8"     1/2"     5/8"  
 3/4"     1"

- Accessories:  
 Unions  
 Vent/Purge Assembly  
 Trunk Isolation Valve  
 Balancing Valves - Supply  
 Balancing Valves - Return  
 No Balancing

- Connections:  
 Crimp Fittings  
 SlideLock Fittings  
 Compression Fittings

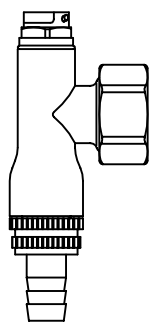
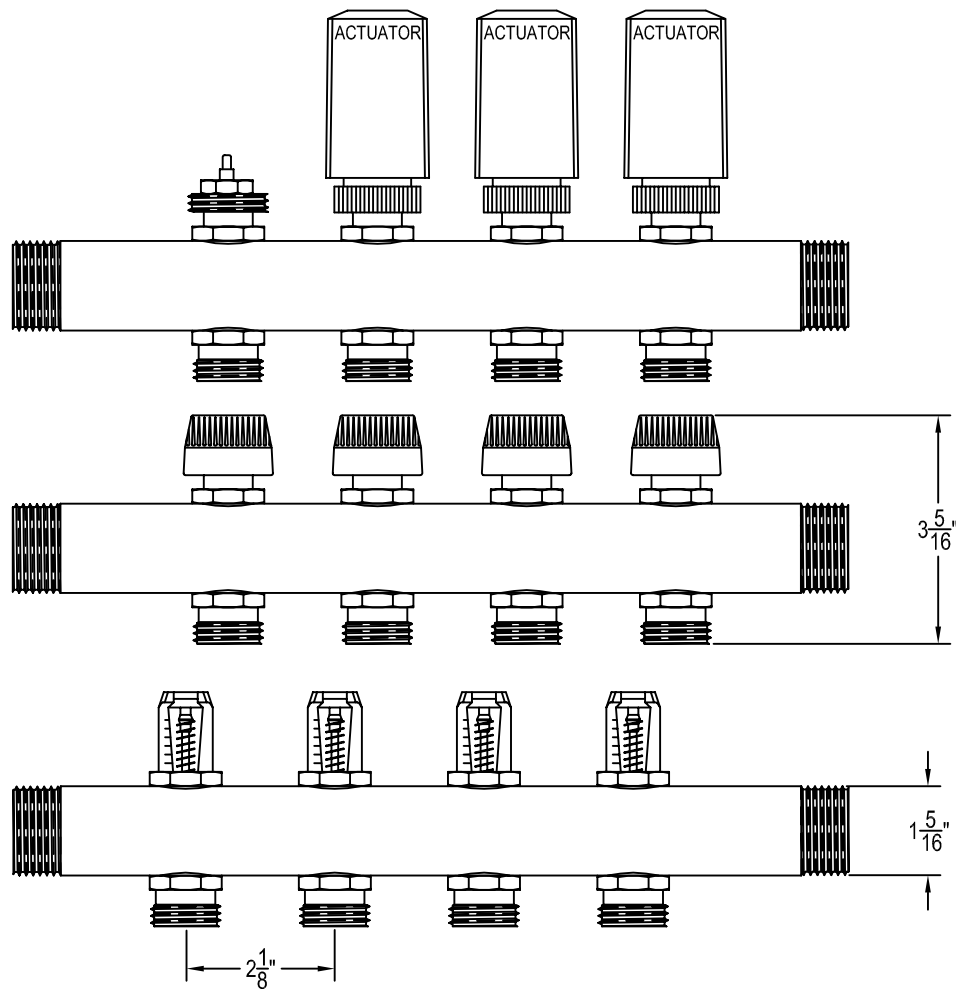

Vent/Purge End Assembly

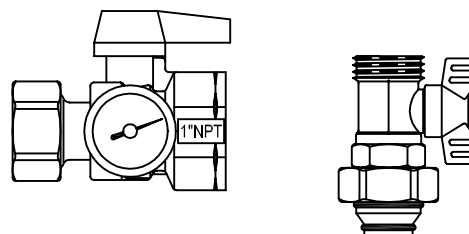

Trunk and Circuit Valves

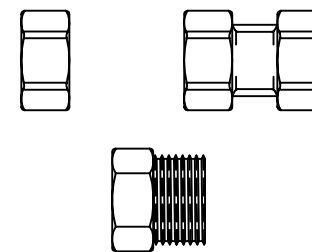

End Cap, Coupling and Transitional Fitting